

Ionic Clean[®]

Instruction Manual

About the Ionic Clean[®] Washing System

The Ionic Clean[®] uses de-ionizing (DI) technology to create purified water that has unique cleaning properties. As water flows through the Ionic Clean, positive and negative ionic exchange occurs. This removes the minerals and impurities that would normally remain on a surface and cause spots as the water dries. It also leaves the Ionic Clean hungry, looking to regain the ionic particles removed during the exchange. So, the Ionic Clean becomes an aggressor - actively gathering the minerals and impurities that are now off the surface and in the rinse water. These rinse away, leaving an ultra-clean, spot-free surface.

For window cleaning, the big benefit is that you can clean every window in your house without the use of chemicals that can harm plants. Beyond windows, the Ionic Clean is designed to attach to a standard garden hose, so you can use it for a variety of cleaning projects, particularly vehicle washing.

The Ionic Clean features a three-way selector with "Off," "DI" rinse, and "Bypass" wash modes. The "Bypass" mode is for initial cleaning and utilizes high velocity tap water. This conserves DI water to extend the filter life. The "DI" mode is used for the final clean/rinse step. The DI mode routes water through the DI filter and is flow-restricted to approximately 0.7 gallons per minute. "Off" mode simply shuts off the water flow from the hose. There is also a water shutoff that attaches to the end of the extension pole. This telescopic flow-through pole extends your reach up to 63".

For dual cleaning action, the specially designed brush head incorporates a nozzle that's designed to direct the water flow to the surface.

CAUTIONS/WARNINGS

- De-ionized water is not recommended for drinking.
- When using the telescopic extension, be sure to stay away from power lines, as serious injury or death could occur.
- Stay away from any electric power sources, including but not limited to extension cords, external outlets, etc.
- Contents under pressure.
- Keep the brush clean. Debris in brush can cause surface damage.
- Use the built-in handle for moving the unit. Do not pull with attached hoses, as this could damage the product.
- Use city water pressure only. Maximum allowable pressure is 80 psi (552 kPa).



KIT CONTENTS

(components shown are not to scale)

1. Housing (unit) with filter
2. Brush
3. Quick-disconnect fitting-female
4. Quick-disconnect fitting-male
5. On/off valve
6. DI water quality tester
7. Telescopic pole

GETTING STARTED

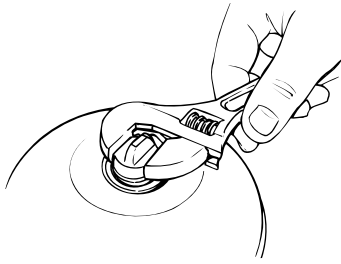

Remove the factory-installed plug from the inlet on the side of the unit. (You may need a wrench or pliers.) Retain plug to use when storing unit.

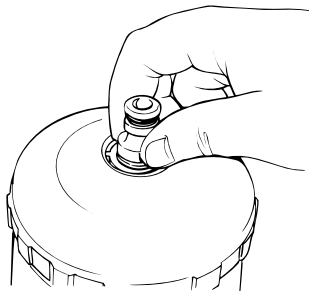

Replace it with the male portion of the quick-connect fitting.

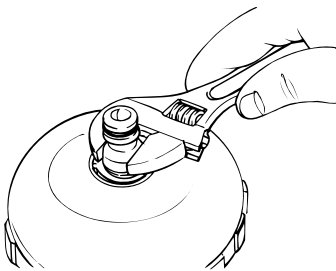

Snug the male side with a wrench or pliers. **DO NOT OVERTIGHTEN.**

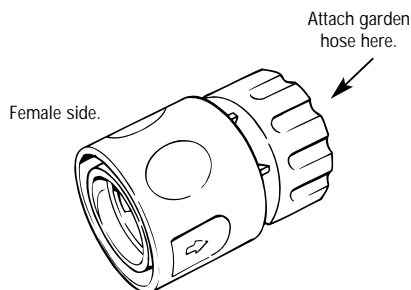

Connect the hose attachment fitting to your garden hose.

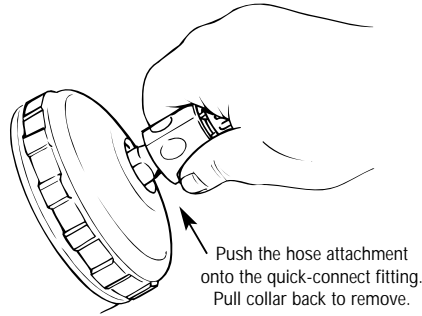

Push the hose attachment onto the quick-connect fitting. Pull collar back to remove.

Then attach the female side of the hose attachment to the male portion of the quick-connect fitting you just attached to the Ionic Clean unit.

Now attach the brush to the end of the telescopic pole and the pole to the outlet hose fitting on the Ionic Clean unit.

USING THE UNIT

✓ TIP

Turn the selector to "By-pass" for the initial wash. Then rinse in the "DI" setting. ("DI" stands for "de-ionized.") This extends the life of the filter.

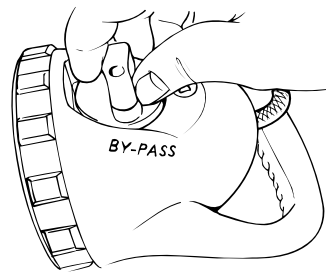

Turn the selector setting to "by-pass," turn on water, and begin cleaning with the brush directly on the surface. By setting the dial to "by-pass," you will be using normal tap water for this initial cleaning. De-ionized water isn't necessary for this step, and you'll be extending the life of the Ionic Clean filter. (Note: If what you're cleaning is excessively dirty, you may need to use the optional soap injector. Use with any mild liquid soap.)

✓ TIP

Always wash from the top down. If you're cleaning windows, clean the window frame and molding, too.

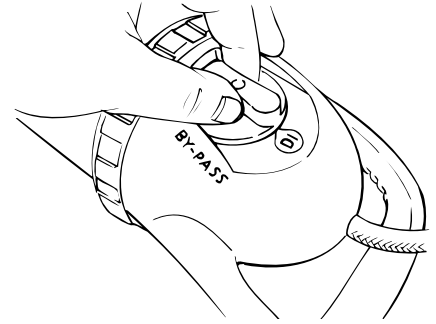

After the initial cleaning, turn the dial to the "DI" setting.

When switching from the "By-pass" to the "DI" setting, it will take ten seconds before beginning the rinse, to allow any non-DI water to leave the system.

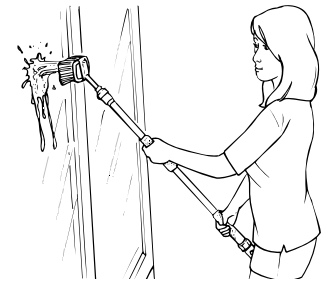

Go over surface quickly with the brush and then hold it about **6" off the surface** and rinse from the top down. You're now using de-ionized water that's removing the dirt. The water contains no minerals that leave streaks or spots when it dries.

You're done! Let the surface dry completely. You'll notice a crystal-clear finish you could never get with a towel or chamois!

When you're done, there's no need to dry or squeegee, even in direct sunlight.

✓ TIP

When switching from "By-pass" to "DI," don't let the surface begin to dry, as water spots will begin to form.

REPLACING THE FILTER

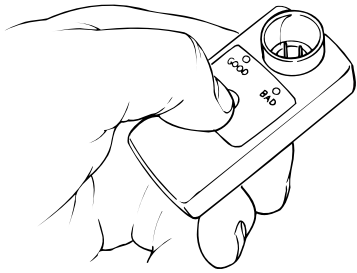

Periodically, use the water tester to check the water exiting the unit while in the "DI" setting. Simply let some water fill the reservoir on the tester and press the button. Check after cleaning every few windows. If the tester reads "bad," replace the filter:

1. Turn off the supply water. Turn the switch back and forth once between "DI" and By-pass" to relieve water pressure in the unit. Leave it in the "by-pass" position.
2. Remove the garden hose by releasing the quick-disconnect fitting.
3. Remove the inlet end cover by turning it counter-clockwise. If it's tight, tap the unit gently on a tabletop or other flat, smooth surface.

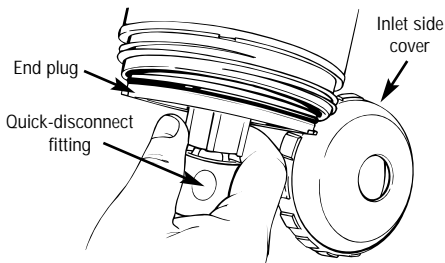

4. Remove the end plug from the unit by pulling and wiggling the male portion of the quick-disconnect fitting. For extra leverage, attach the female quick-disconnect fitting. (Note: Do not use tools to remove the end plug, as damage to the seal could occur.)

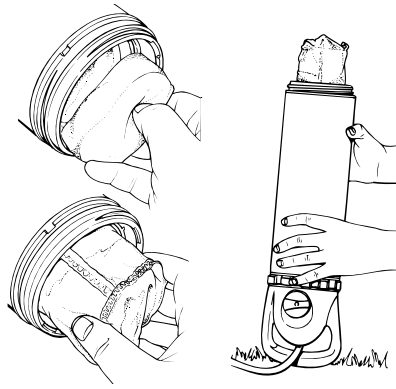

5. Remove the black foam spacer and retain. Remove filter. Replace with a new filter. If needed, gently tap the unit on a table or other hard surface to help move the filter into the cavity. Replace the black foam spacer.

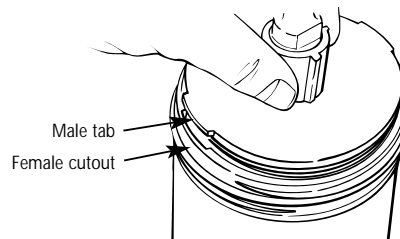

6. To make reassembly easier, lubricate the plug's black o-ring with a thin coat of Vaseline® or other petroleum jelly. Align the two male tabs on the plug with the female cut-outs on the body of the unit. (See illustration above.) Press the plug into the body until it's flush with the unit.
7. Verify that the green Flow Regulator is properly seated in the Valve Cap. (See #s 6 and 7 of the exploded drawing on the next page.)
8. Reinstall the inlet end cover.
9. Attach the hose, and the unit is ready to use again.

USEFUL TIPS

- Use the Ionic Clean for cleaning and rinsing windows, cars, boats, RVs, or anything that requires a spot-free rinse.
- When switching from "By-pass" to "DI" setting, it will take about 10 seconds before beginning the rinse, to allow any non-DI water to leave the system.
- When in "DI" setting, use the nozzle spray (not the brush) for the final rinse.
- You always have the option to clean surfaces while the unit is in the "DI" setting. However, this is not recommended, as it unnecessarily reduces the life of the filter. If you notice spotting on the surface, you may not be using enough de-ionized water. Be sure to rinse thoroughly. You may also need to change the filter. (See "Replacing the Filter.")
- You can extend the handle up to 63" for hard-to-reach places.

STORING

Filter life is about six months when not in use.

FILTER LIFE CALCULATOR*

Total dissolved solids in your water (water hardness)	Output of one filter (gallons)	Minimum run time (minutes)
100	94	142
Average 200	47	71
300	31	47
400	23	35

*For reference only. Your actual filter life may vary.

OPTIONAL ACCESSORIES

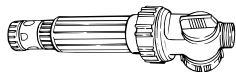

Soap/Chemical Injector (C800745)

Attaches to telescopic pole. Use with any mild soap to clean particularly dirty areas.



Spray Cleaning Wand (C817100)

Ideal for rinsing smaller areas and items where tighter control of the water flow is required.



Boar's Hair Brush (C817114)

A natural-bristle brush that is extremely gentle on finely finished surfaces.

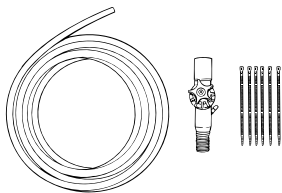

Long-Extension Pole Kit (C817015)

Use to connect the Ionic Clean to an extension pole of up to 30 feet. (Pole not included.)

REPLACEMENT PARTS



Brush (C817104)

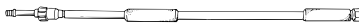

Telescopic Pole (C817105)



Filters

(C800744 - one pack, C800757 - four pack)
Replace as needed to ensure your Ionic Clean is dispensing fully de-ionized water.

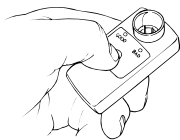

Filter-Life Tester

(C820406)

Tests to ensure water is fully de-ionized.

For troubleshooting questions or problems or to order accessories or replacement parts, contact HOME RIGHT at 763-780-5115 or 800-264-5442. You also can go to www.homeright.com.

WARRANTY

HOME RIGHT® warrants this product from any defects in material or workmanship for two years from the date of purchase, when it is maintained and operated according to the instructions in the Instruction Manual. HOME RIGHT will repair or replace defective product at no charge and return postage-paid to you. This warranty does not cover accessories or damage resulting from improper use, negligence, accidents, or normal wear and tear. This warranty is void if the product is used for commercial or rental purposes.

Any implied warranty or merchantability or fitness for a particular purpose is limited to two years following date of purchase.

Responsibility is limited to the repair or replacement for defects in material or workmanship. HOME RIGHT shall not in any event be liable for any incidental or consequential damages of any kind, whether for breach of this warranty or any other reason.

Some states do not allow a limitation on how long implied warranties last or the exclusion of incidental or consequential damages, so the above limitation and exclusion may not apply to you.

This warranty gives you specific legal rights, and you may also have other rights which vary from state to state.

For warranty service, send your product postage-paid along with a description of the problem to: HOME RIGHT, Warranty Dept., 1661 94th Lane N.E., Minneapolis, MN 55449 or call customer service at 1-800-264-5442, 763-780-5115 for further assistance.

SPECIFICATIONS

By-Pass Flow Rate: 2.0/gal./min.

DI Flow Rate: .7/gal./min.

Maximum PSI: 80

Hose Length: 20 feet

Telescopic Pole Length: up to 64 inches

PARTS LIST

Item	Description	Part No.
1.	Hose	C817125
2.	Handle	C817126
3.	Control Knob	C817127
4.	Valve Arm	C817128
5.	Clamp	C817129
6.	Valve Cap	C817130
7.	Flow Regulator	C817071
8.	Body Cylinder	C817131
9.	End Plug	C817132
10.	Inlet End Cover	C817133
11.	Quick-Disconnect - Male	C817134
12.	Quick Disconnect - Female	C817135
13.	Filter	C817101
14.	Foam Spacer	C817136
15.	Threaded Storage Plug	C817106
16.	O-Ring Replacement Kit (Not shown)	C817137

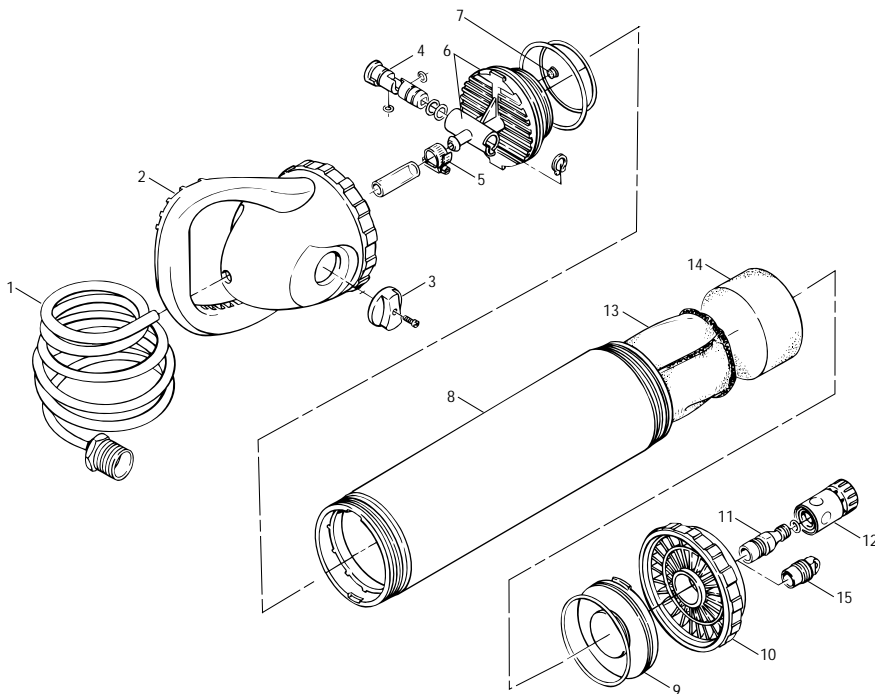

1661 94th Lane N.E., Minneapolis, Minnesota 55449-4324 • Phone: 763-780-5115 • Fax: 763-785-5727
Customer Service Line: 1-800-264-5442, 8:00 a.m. to 5:00 p.m. CST • www.homeright.com

LITERATURE PN C820411
COPYRIGHT 2009
REV A 6/09